

FEATURES

- Complete angular rate gyroscope
- Z-axis (yaw rate) response
- SPI digital output interface
- High vibration rejection over wide frequency
- 2000 *g*-powered shock survivability
- Externally controlled self-test
- Internal temperature sensor output
- Dual auxiliary 12-bit ADC inputs
- Absolute rate output for precision applications
- 5 V single-supply operation
- 8.2 mm × 8.2 mm × 5.2 mm package
- RoHS compliant

APPLICATIONS

- Platform stabilization
- Image stabilization
- Guidance and control
- Inertia measurement units
- Robotics

GENERAL DESCRIPTION

The ADIS16080 is a gyroscope that uses the Analog Devices, Inc. surface-micromachining process to make a functionally complete angular rate sensor with an integrated serial peripheral interface (SPI).

The digital data available at the SPI port is proportional to the angular rate about the axis that is normal to the top surface of the package (see Figure 20). A single external resistor can be used to increase the measurement range. An external capacitor can be used to lower the bandwidth.

Access to an internal temperature sensor measurement is provided, through the SPI, for compensation techniques. Two pins are available for the user to input analog signals for digitization. An additional output pin provides a precision voltage reference. Two digital self-test inputs electromechanically excite the sensor to test the operation of the sensor and the signal-conditioning circuits.

The ADIS16080 is available in an 8.2 mm × 8.2 mm × 5.2 mm, 16-terminal, peripheral land grid array (LGA) package.

FUNCTIONAL BLOCK DIAGRAM

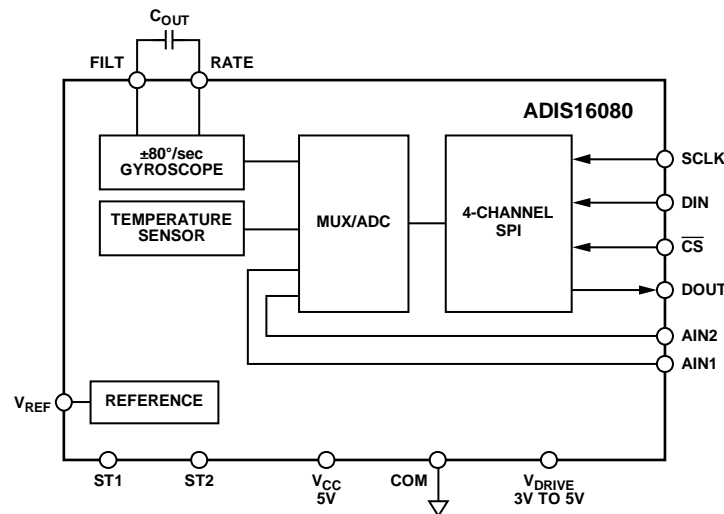

Figure 1.

Rev. A

Information furnished by Analog Devices is believed to be accurate and reliable. However, no responsibility is assumed by Analog Devices for its use, nor for any infringements of patents or other rights of third parties that may result from its use. Specifications subject to change without notice. No license is granted by implication or otherwise under any patent or patent rights of Analog Devices. Trademarks and registered trademarks are the property of their respective owners.

TABLE OF CONTENTS

Features	1	Supply and Common Considerations	11
Applications.....	1	Increasing Measurement Range	11
General Description	1	Setting Bandwidth.....	11
Functional Block Diagram	1	Self-Test Function	11
Revision History	2	Continuous Self-Test.....	11
Specifications.....	3	Rate Sensitive Axis	11
Timing Specifications	5	Basic Operation	12
Absolute Maximum Ratings.....	6	Serial Peripheral Interface (SPI).....	12
ESD Caution.....	6	Outline Dimensions	14
Pin Configuration and Function Descriptions.....	7	Ordering Guide	14
Typical Performance Characteristics	8		
Theory of Operation	11		

REVISION HISTORY

4/07—Rev. 0 to Rev. A

Changes to Table 1.....	3
Changes to Table 4.....	7
Added Figure 5.....	7
Changes to Setting Bandwidth Section.....	11
Changes to Rate Sensitive Axis Section.....	11
Deleted Control Register Section	12
Added Basic Operation Section.....	12
Updated Outline Dimensions	14

7/06—Revision 0: Initial Version

SPECIFICATIONS

$T_A = 25^\circ\text{C}$, $V_{CC} = V_{DRIVE} = 5\text{ V}$, angular rate = $0^\circ/\text{sec}$, $C_{OUT} = 0\ \mu\text{F}$, $\pm 1\text{ g}$, unless otherwise noted.

Table 1.

Parameter	Conditions	Min ¹	Typ	Max ¹	Unit
SENSITIVITY					
Dynamic Range ²	Full-scale range over specifications range	± 80			$^\circ/\text{sec}$
Initial	Clockwise rotation is positive output, $T_A = -40^\circ\text{C}$ to $+85^\circ\text{C}$	0.08881	0.09766	0.10858	$^\circ/\text{sec}/\text{LSB}$
Change over Temperature ³	$V_{CC} = V_{DRIVE} = 4.75\text{ V}$ to 5.25 V		± 5		%
Nonlinearity	Best fit straight line		0.12		$^\circ/\text{sec}$
Voltage Sensitivity	$V_{CC} = V_{DRIVE} = 4.75\text{ V}$ to 5.25 V		0.56		$^\circ/\text{sec}$
NULL					
Initial	Nominal $0^\circ/\text{sec}$ output is 2048 LSB	-41		+41	$^\circ/\text{sec}$
Change Over Temperature ³	$V_{CC} = V_{DRIVE} = 4.75\text{ V}$ to 5.25 V		± 8.3		$^\circ/\text{sec}$
Turn-On Time	Power on to $\pm 0.5^\circ/\text{sec}$ of final value		35		ms
Linear Acceleration Effect	Any axis		0.2		$^\circ/\text{sec}/\text{g}$
Voltage Sensitivity	$V_{CC} = V_{DRIVE} = 4.75\text{ V}$ to 5.25 V		± 1		$^\circ/\text{sec}/\text{V}$
NOISE PERFORMANCE					
Total Noise	0.1 Hz to 40 Hz, no averaging		0.42		$^\circ/\text{sec rms}$
Rate Noise Density	@ 25°C		0.05		$^\circ/\text{sec}/\sqrt{\text{Hz}}$
FREQUENCY RESPONSE					
3 dB Bandwidth (User-Selectable) ⁴	$C_{OUT} = 0\ \mu\text{F}$		40		Hz
Sensor Resonant Frequency			14		kHz
SELF-TEST INPUTS					
ST1 Rateout Response ⁵	ST1 pin from Logic 0 to Logic 1	-328	-540	-819	LSB
ST2 Rateout Response ⁵	ST2 pin from Logic 0 to Logic 1	+328	+540	+819	LSB
Logic 1 Input Voltage	Standard high logic level definition	3.3			V
Logic 0 Input Voltage	Standard low logic level definition			1.7	V
Input Impedance	To common		50		k Ω
TEMPERATURE SENSOR					
Reading at 298 K			2048		LSB
Scale Factor	Proportional to absolute temperature		0.1453		K/LSB
2.5 V REFERENCE					
Voltage Value		2.45	2.5	2.55	V
Load Drive to Ground	Source		100		μA
Load Regulation	$0\ \mu\text{A} < I_{OUT} < 100\ \mu\text{A}$		5.0		mV/mA
Power Supply Rejection	$V_{CC} = V_{DRIVE} = 4.75\text{ V}$ to 5.25 V		1.0		mV/V
Temperature Drift	Delta from 25°C		5.0		mV
LOGIC INPUTS					
Input High Voltage, V_{INH}		$0.7 \times V_{DRIVE}$			V
Input Low Voltage, V_{INL}				$0.3 \times V_{DRIVE}$	V
Input Current, I_{IN}	Typically 10 nA	-1		+1	μA
Input Capacitance, C_{IN}			10		pF
ANALOG INPUTS					
Resolution	For $V_{IN} < V_{CC}$		12		Bits
Integral Nonlinearity		-2		+2	LSB
Differential Nonlinearity		-2		+2	LSB
Offset Error		-8		+8	LSB
Gain Error		-2		+2	LSB
Input Voltage Range		0		$V_{REF} \times 2$	V
Leakage Current		-1		+1	μA
Input Capacitance			20		pF
Full Power Bandwidth			8		MHz

ADIS16080

Parameter	Conditions	Min ¹	Typ	Max ¹	Unit
DIGITAL OUTPUTS					
Output High Voltage (V _{OH})	I _{SOURCE} = 200 μA	V _{DRIVE} - 0.2			V
Output Low Voltage (V _{OL})	I _{SINK} = 200 μA			0.4	V
CONVERSION RATE					
Conversion Time	16 SCLK cycles with SCLK at 20 MHz			800	ns
Throughput Rate				1	MSPS
POWER SUPPLY					
V _{CC}	All at T _A = -40°C to +85°C	4.75	5	5.25	V
V _{DRIVE}		2.7		5.25	V
V _{CC} Quiescent Supply Current	V _{CC} @ 5 V, f _{SCLK} = 50 kSPS		7.0	9.0	mA
V _{DRIVE} Quiescent Supply Current	V _{DRIVE} @ 5 V, f _{SCLK} = 50 kSPS		70	500	μA
Power Dissipation	V _{CC} and V _{DRIVE} @ 5 V, f _{SCLK} = 50 kSPS		40		mW
TEMPERATURE RANGE					
Specified Performance	Tested to max and min specifications	-40		+85	°C

¹ All minimum and maximum specifications are guaranteed. Typical specifications are neither tested nor guaranteed.

² Dynamic range is the maximum full-scale measurement range possible, including output swing range, initial offset, sensitivity, offset drift, and sensitivity drift at 5 V supply.

³ Defined as the output change from ambient to maximum temperature, or ambient to minimum temperature.

⁴ Frequency at which the response is 3 dB down from dc response. Bandwidth = $1/(2 \times \pi \times 180 \text{ k}\Omega \times (22 \text{ nF} + C_{OUT}))$. For C_{OUT} = 0, bandwidth = 40 Hz. For C_{OUT} = 1 μF, bandwidth = 0.87 Hz.

⁵ Self-test response varies with temperature.

TIMING SPECIFICATIONS

T_A = 25°C, angular rate = 0°/sec, unless otherwise noted.¹

Table 2.

Parameter	V _{CC} = V _{DRIVE} = 5 V	Unit	Description
f _{SCLK} ²	10 20	kHz min MHz max	
t _{CONVERT}	16 × t _{SCLK}		
t _{QUIET}	50	ns min	Minimum quiet time required between \overline{CS} rising edge and start of next conversion.
t ₂	10	ns min	\overline{CS} to SCLK setup time.
t ₃ ³	30	ns max	Delay from \overline{CS} until DOUT three-state disabled.
t ₄ ³	40	ns max	Data access time after SCLK falling edge.
t ₅	0.4 × t _{SCLK}	ns min	SCLK low pulse width.
t ₆	0.4 × t _{SCLK}	ns min	SCLK high pulse width.
t ₇	10	ns min	SCLK to DOUT valid hold time.
t ₈ ⁴	15/35	ns min/max	SCLK falling edge to DOUT high impedance.
t ₉	10	ns min	DIN setup time prior to SCLK falling edge.
t ₁₀	5	ns min	DIN hold time after SCLK falling edge.
t ₁₁	20	ns min	16 th SCLK falling edge to \overline{CS} high.

¹ Guaranteed by design. All input signals are specified with t_r and t_f = 5 ns (10% to 90% of V_{CC}) and timed from a voltage level of 1.6 V. The 5 V operating range spans from 4.75 V to 5.25 V.

² Mark/space ratio for the SCLK input is 40/60 to 60/40.

³ Measured with the load circuit in Figure 3 and defined as the time required for the output to cross 0.4 V, or 0.7 × V_{DRIVE}.

⁴ t₈ is derived from the measured time taken by the data outputs to change 0.5 V when loaded with the circuit in Figure 3. The measured number is then extrapolated back to remove the effects of charging or discharging the 50 pF capacitor. This means that the time, t₈, quoted in the timing characteristics is the true bus relinquish time of the part and is independent of the bus loading.

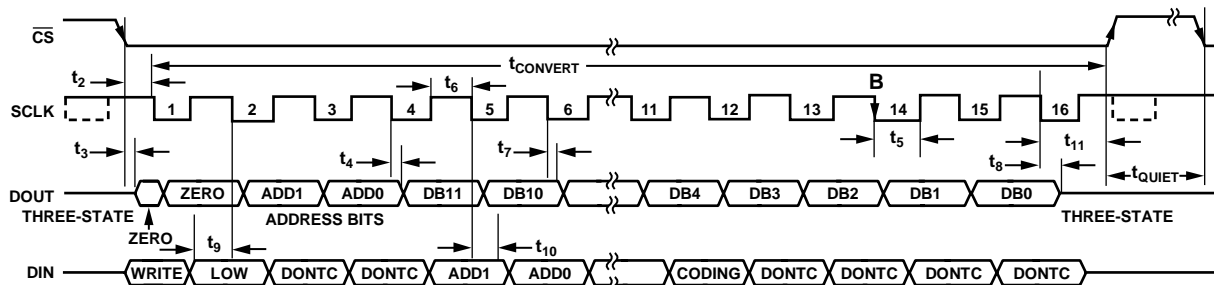

Figure 2. Gyroscope Serial Interface Timing Diagram

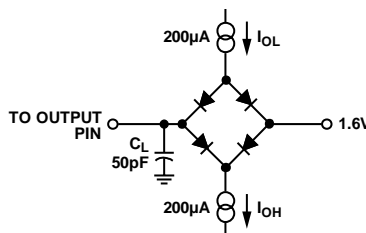

Figure 3. Load Circuit for Digital Output Timing Specifications

ABSOLUTE MAXIMUM RATINGS

Table 3.

Parameter	Rating
Acceleration (Any Axis, Unpowered, 0.5 ms)	2000 <i>g</i>
Acceleration (Any Axis, Powered, 0.5 ms)	2000 <i>g</i>
V _{CC} to COM	-0.3 V to +6.0 V
V _{DRIVE} to COM	-0.3 V to V _{CC} + 0.3 V
Analog Input Voltage to COM	-0.3 V to V _{CC} + 0.3 V
Digital Input Voltage to COM	-0.3 V to +7.0 V
Digital Output Voltage to COM	-0.3 V to V _{CC} + 0.3 V
ST1/ST2 Input Voltage to COM	-0.3 V to V _{CC} + 0.3 V
Operating Temperature Range	-55°C to +125°C
Storage Temperature Range	-65°C to +150°C

Stresses above those listed under the Absolute Maximum Ratings may cause permanent damage to the device. This is a stress rating only; functional operation of the device at these or any other conditions above those indicated in the operational section of this specification is not implied. Exposure to absolute maximum rating conditions for extended periods may affect device reliability.

Drops onto hard surfaces can cause shocks of greater than 2000 *g* and exceed the absolute maximum rating of the device. Care should be exercised in handling to avoid damage.

ESD CAUTION



ESD (electrostatic discharge) sensitive device. Charged devices and circuit boards can discharge without detection. Although this product features patented or proprietary protection circuitry, damage may occur on devices subjected to high energy ESD. Therefore, proper ESD precautions should be taken to avoid performance degradation or loss of functionality.

PIN CONFIGURATION AND FUNCTION DESCRIPTIONS

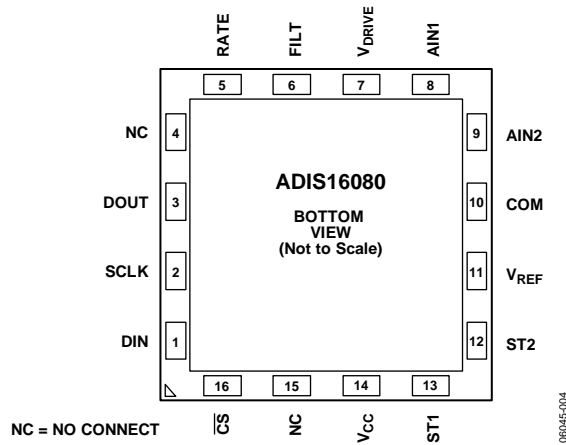

Figure 4. Pin Configuration

Table 4. Pin Function Descriptions

Pin No.	Mnemonic	Type ¹	Description
1	DIN	I	SPI Data Input.
2	SCLK	I	SPI Serial Clock.
3	DOUT	O	SPI Data Output.
4	NC		No Connect.
5	RATE	O	Buffered Analog Output. Represents the angular rate signal.
6	FILT	I	External Capacitor Connection to Control Bandwidth.
7	V _{DRIVE}	S	SPI Power Supply. This can be the receive processing circuit's supply to simplify interfacing.
8	AIN1	I	External Analog Input Channel 1. See ADD0 and ADD1 address bits in Table 5.
9	AIN2	I	External Analog Input Channel 2. See ADD0 and ADD1 address bits in Table 5.
10	COM	S	Common. Reference point for all circuitry in the ADIS16080.
11	V _{REF}	O	Precision 2.5 V Reference.
12	ST2	I	Self-Test Input 2.
13	ST1	I	Self-Test Input 1.
14	V _{CC}	S	Analog Power.
15	NC		No Connect.
16	$\overline{\text{CS}}$	I	Chip Select. Active low. This input frames the serial data transfer and initiates the conversion process.

¹ I = input; O = output; S = power supply.

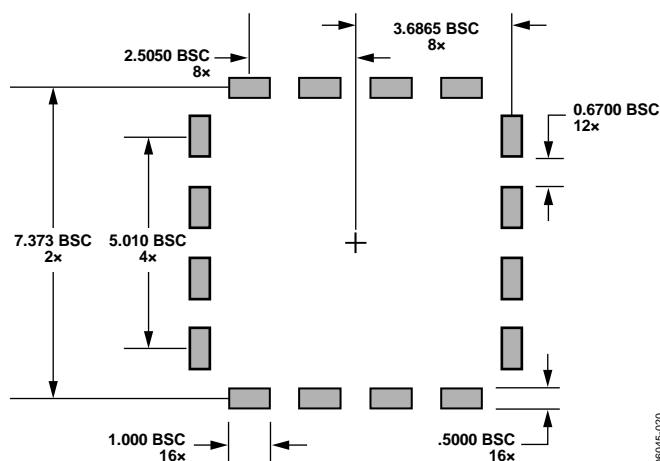

Figure 5. Second-Level Assembly Pad Layout

TYPICAL PERFORMANCE CHARACTERISTICS

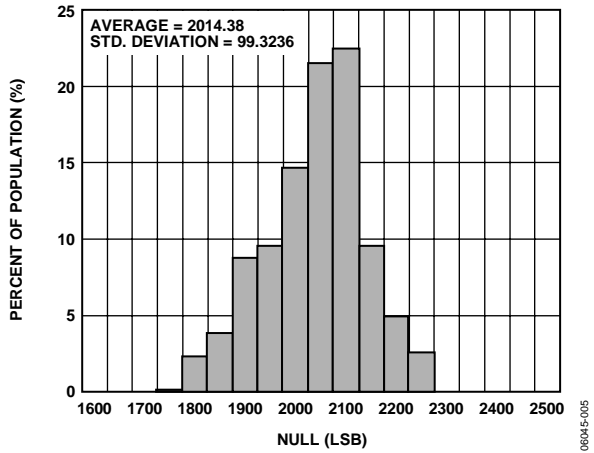

Figure 6. Initial Null Histogram

06045-006

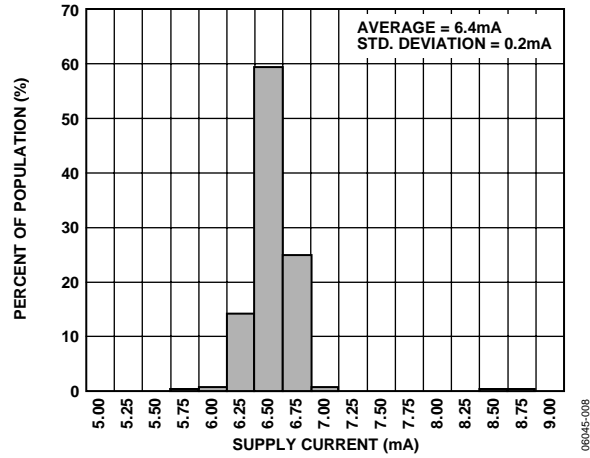

Figure 9. Supply Current Histogram

06045-008

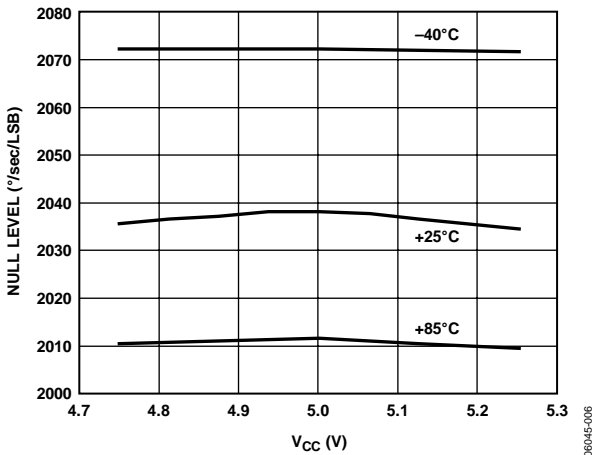

Figure 7. Null Level vs. Supply Voltage

06045-006

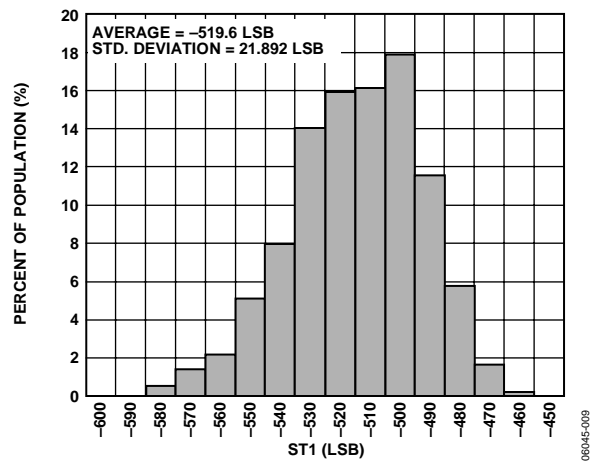

Figure 10. Self-Test 1 Histogram

06045-009

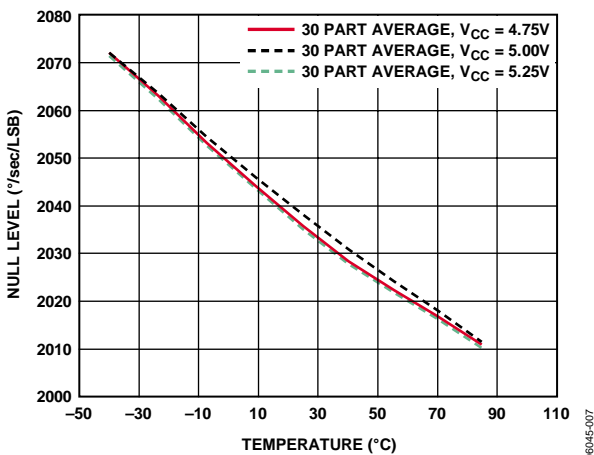

Figure 8. Null Level vs. Temperature

06045-007

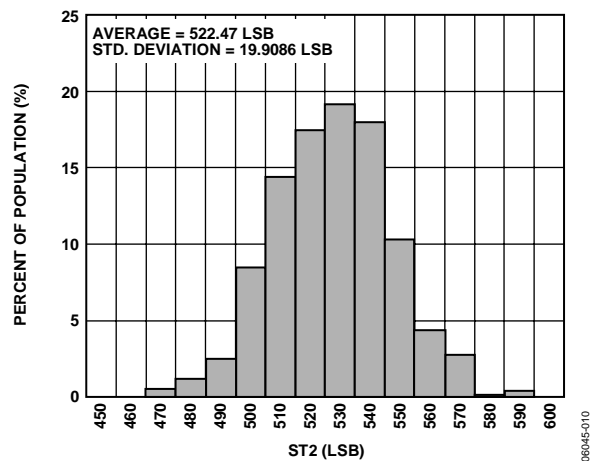

Figure 11. Self-Test 2 Histogram

06045-010

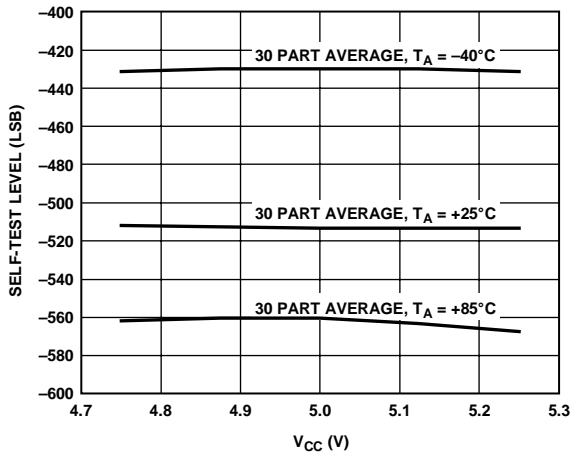

Figure 12. Self-Test 1 vs. Supply Voltage

06045-011

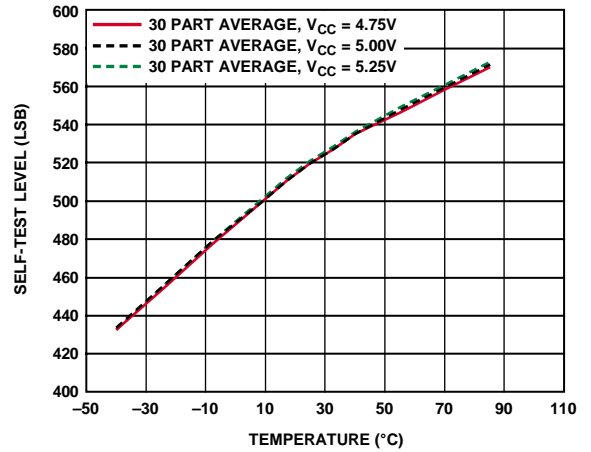

Figure 15. Self-Test 2 vs. Temperature

06045-014

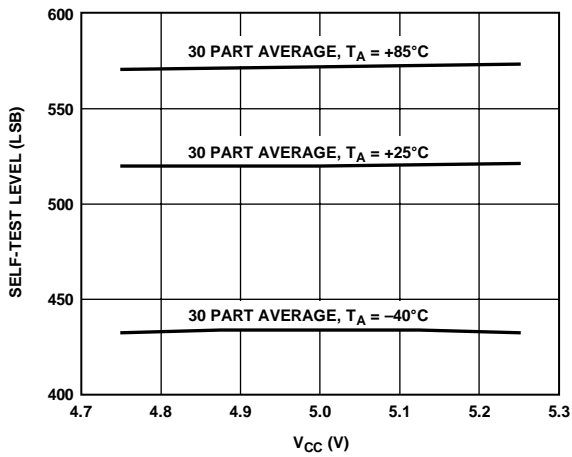

Figure 13. Self-Test 2 vs. Supply Voltage

06045-012

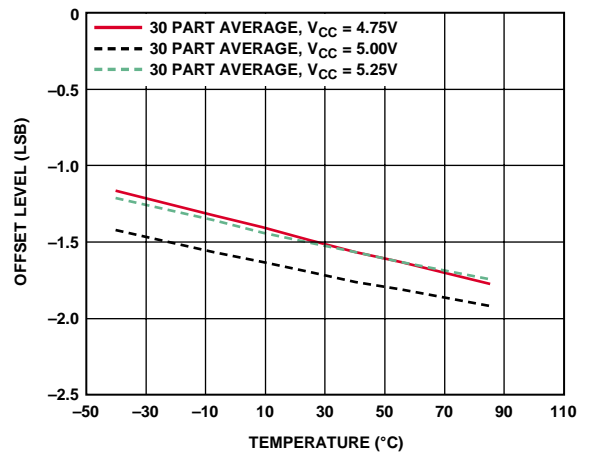

Figure 16. ADC Offset vs. Temperature and Supply Voltage

06045-015

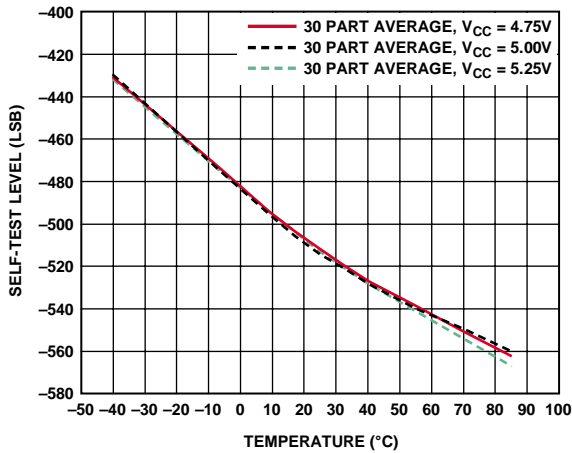

Figure 14. Self-Test 1 vs. Temperature

06045-013

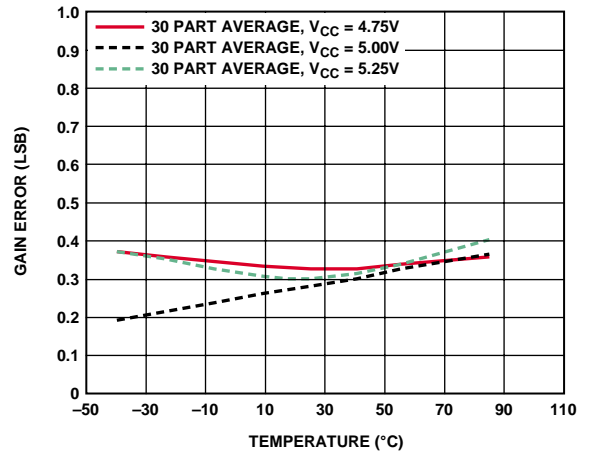

Figure 17. ADC Gain Error vs. Temperature (Excluding V_{REF})

06045-016

ADIS16080

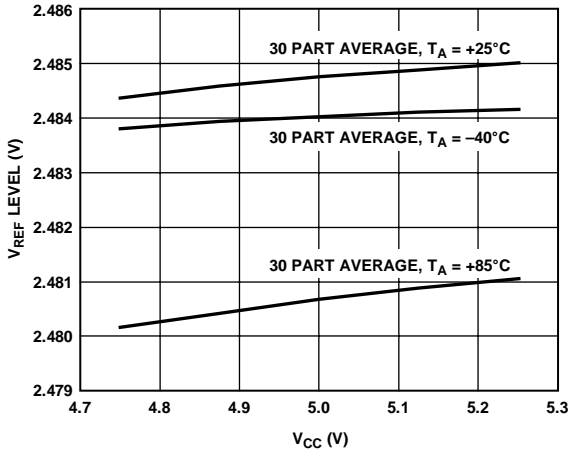

Figure 18. V_{REF} vs. Supply Voltage

06045-017

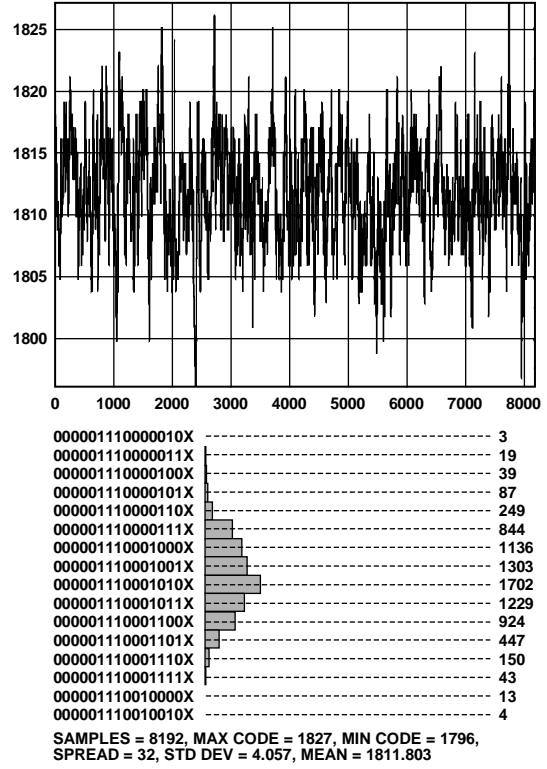

Figure 19. Noise Histogram

06045-018

THEORY OF OPERATION

The ADIS16080 operates on the principle of a resonator gyroscope. Two polysilicon sensing structures each contain a dither frame that is electrostatically driven to resonance. This produces the necessary velocity element to produce a Coriolis force while rotating. At two of the outer extremes of each frame, orthogonal to the dither motion, are movable fingers that are placed between fixed pickoff fingers to form a capacitive pickoff structure that senses Coriolis motion. The resulting signal is fed to a series of gain and demodulation stages that produce the electrical rate signal output. The rate signal is then converted to a digital representation of the output on the SPI pins. The dual-sensor design rejects external g forces and vibration. Fabricating the sensor with the signal conditioning electronics preserves signal integrity in noisy environments.

The electrostatic resonator requires 14 V to 16 V for operation. Because only 5 V is typically available in most applications, a charge pump is included on-chip. After the demodulation stage, there is a single-pole, low-pass filter included on-chip that is used to limit high frequency artifacts before final amplification. The frequency response is dominated by the second low-pass filter, which is set at 40 Hz. For additional bandwidth reduction options, see the Setting Bandwidth section.

SUPPLY AND COMMON CONSIDERATIONS

Power supply noise and transient behaviors can influence the accuracy and stability of any sensor-based measurement system. When considering the power supply for the ADIS16080, it is important to understand that the ADIS16080 provides 0.2 μF of decoupling capacitance on the V_{CC} pin. Depending on the level of noise present in the system power supply, the ADIS16080 may not require any additional decoupling capacitance for this supply. The analog supply, V_{CC} , and the digital drive supply, V_{DRIVE} , are segmented to allow multiple logic levels to be used in receiving the digital output data. V_{DRIVE} is intended for the down-stream logic power supply and supports standard 3.3 V and 5 V logic families. The V_{DRIVE} supply does not have internal decoupling capacitors.

INCREASING MEASUREMENT RANGE

The full-scale measurement range of the ADIS16080 is increased by placing an external resistor between the RATE pin and FILT pin, which results in a parallel connection with the internal 180 k Ω , 1% resistor. For example, a 330 k Ω external resistor gives ~50% increase in the full-scale range. This is effective for up to a 4 \times increase in the full-scale range (minimum value of the parallel resistor allowed is 45 k Ω). The internal circuitry headroom requirements prevent further increase in the linear full-scale output range. The trade-offs associated with increasing the full-scale range are potential increase in output null drift (as much as 2 $^\circ$ /sec over temperature) and introducing initial null bias errors that must be calibrated.

SETTING BANDWIDTH

An external capacitor can be used in combination with an on-chip resistor to create a low-pass filter to limit the bandwidth of the ADIS16080 rate response.

The -3 dB frequency is defined as

$$f_{\text{OUT}} = 1 / (2 \times \pi \times R_{\text{OUT}} \times (C_{\text{OUT}} + 0.022 \mu\text{F}))$$

where:

R_{OUT} is the internal impedance that was trimmed during manufacturing to 180 k $\Omega \pm 1\%$.

C_{OUT} is the external capacitance across the RATE and FILT pins.

Any external resistor applied between the RATE pin and the FILT pin results in

$$R_{\text{OUT}} = (180 \text{ k}\Omega \times R_{\text{EXT}}) / (180 \text{ k}\Omega + R_{\text{EXT}})$$

where R_{EXT} is the external resistor.

With $C_{\text{OUT}} = 0 \mu\text{F}$, a default -3 dB frequency response of 40 Hz is obtained based upon an internal 0.022 μF capacitor implemented on-chip.

SELF-TEST FUNCTION

The ADIS16080 includes a self-test feature that actuates each of the sensing structures and associated electronics in the same manner as if subjected to an angular rate. It provides a simple method for exercising the mechanical structure of the sensor, along with the entire signal processing circuit. It is activated by standard logic high levels applied to Input ST1, Input ST2, or both. ST1 causes a change in the digital output equivalent to typically -540 LSB, and ST2 causes an opposite +540 LSB change. The self-test response follows the viscosity temperature dependence of the package atmosphere, approximately 0.25%/ $^\circ\text{C}$. Activating both ST1 and ST2 simultaneously is not damaging. Because ST1 and ST2 are not necessarily closely matched, actuating both simultaneously can result in an apparent null bias shift.

CONTINUOUS SELF-TEST

As an additional failure detection measure, a power-on self-test can be performed. However, some applications warrant a continuous self-test while sensing rate.

RATE SENSITIVE AXIS

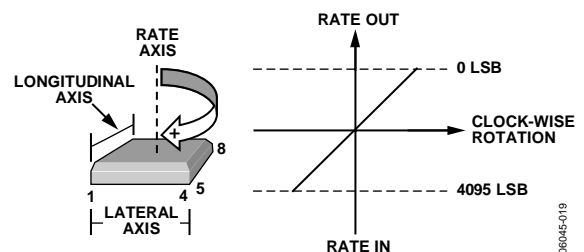

Figure 20. Rate Signal Increases with Clockwise Rotation

BASIC OPERATION

The ADIS16080 is designed for simple integration into industrial system designs, requiring only a 5.0 V power supply and a four-wire, industry standard serial peripheral interface (SPI). The SPI handles all digital I/O communication in the ADIS16080.

SERIAL PERIPHERAL INTERFACE (SPI)

The ADIS16080 SPI port includes four signals: chip select (\overline{CS}), serial clock (SCLK), data input (DIN), and data output (DOUT). The \overline{CS} line enables the ADIS16080 SPI port and frames each SPI event. When this signal is high, the DOUT lines are in a high impedance state and the signals on DIN and SCLK have no impact on operation. A complete data frame contains 16 clock cycles. Because the SPI port operates in full duplex mode, it supports simultaneous, 16-bit receive (DIN) and transmit (DOUT) functions within the same data frame.

Control Register

The DIN control register provides controls for two operational settings: the output data source and the coding (twos complement vs. offset binary). Table 5 and Figure 22 provide the proper bit definitions for control register configuration. The DIN sequence starts with a 1 for configuration sequences and a 0 for read sequences. When this bit is 0, the remaining DIN bits do not change the control register and the next sample's output data reflects the existing configuration. Data loads from the DIN pin into the ADIS16080 on the falling edge of SCLK. Once the 16-SCLK sequence is complete, the control register is updated and ready for the next read sequence. If a data frame has less than 16 SCLK cycles, the control register does not update and maintains its previous configuration. The DIN bit definitions in Table 5, which have either 0 or 1 assigned to them, are critical for proper operation.

ADC Conversion

The chip select (\overline{CS}) and serial clock (SCLK) lines control the on-board A/D conversion process. When the chip select line goes low, the DOUT line comes out of three-state mode, the track-and-hold goes into hold mode, and the ADC samples the analog input at this point. The track-and-hold returns to track mode on the 14th falling edge of the SCLK line. The serial clock drives the internal ADC conversion clock, using its falling edge for control of this process. All 16 SCLK cycles are required for a complete conversion. If a data frame has less than 16 SCLK cycles, the conversion cannot complete and does not update the output data for the next data frame cycle.

Output Data Access

The DOUT sequence starts with two zeros, one that clocks out after the falling edge of \overline{CS} , and a second one that clocks out on the first SCLK falling edge. The next 14 bits, ADD0, ADD1 and the 12 data bits, clock out on SCLK falling edges. After the 16th falling edge, the DOUT line moves to a three-state mode.

When setting up the system process to receive data from the ADIS16080, use a clock phase setting of 0 and a clock polarity setting of 1. These settings reflect the timing displayed in Figure 22. To maintain proper communication at the maximum specified clock rates, the system processor must be able to support the setup time requirement, listed in Figure 2 and Table 2 (t_9).

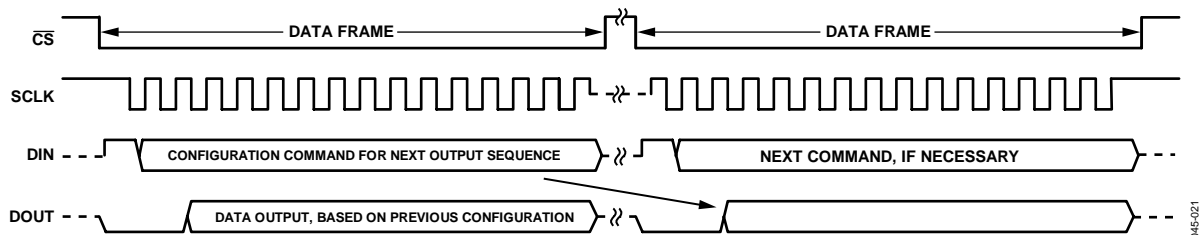

Figure 21. Configuration and Read Sequence

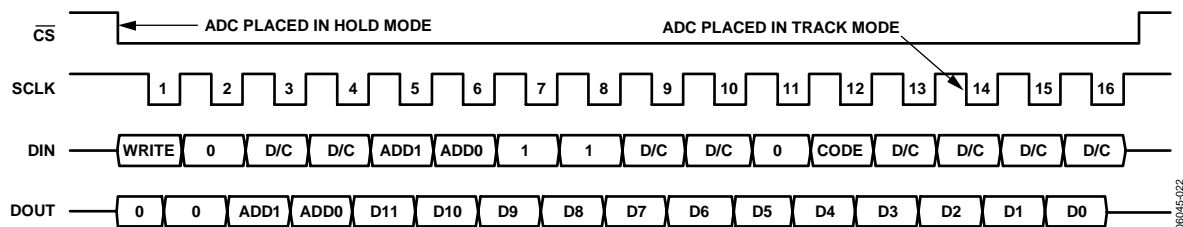

Figure 22. SPI Sequence, Clock Polarity = 1, Clock Phase = 0

Table 5. DIN Bit Assignments

Bit No.	Mnemonic	Comment
15	WRITE	1: Write contents on DIN to control register. 0: No changes to control register.
14	0	Low state for normal operation.
13, 12	D/C	Don't care.
11, 10	ADD1, ADD0	Data source setting. 00: Gyroscope output. 01: Temperature output. 10: Analog input 1. 11: Analog input 2.
9, 8	1	High state for normal operation.
7, 6	D/C	Don't care.
5	0	Low state for normal operation.
4	CODE	Output data format setting. 0: Twos complement. 1: Offset binary.
3 to 0	D/C	Don't care.

Output Coding Examples

Table 6. Gyroscope Data Coding, Twos Complement

Angular Rate (°/sec)	Code	Bit Pattern
80	819	000001100110011
...
0.19532	2	000000000000010
0.09766	1	000000000000001
0	0	000000000000000
-0.09766	-1	000111111111111
-0.19532	-2	000111111111110
...
-80	-819	0000110011001101

Table 7. Gyroscope Data Coding, Offset Binary

Angular Rate (°/sec)	Code	Bit Pattern
80	2867	0000101100110011
...
0.19532	2050	000010000000010
0.09766	2049	000010000000001
0	2048	000010000000000
-0.09766	2047	000111111111111
-0.19532	2046	000111111111110
...
-80	1229	0000010011001101

Table 8. Temperature Data Coding, Twos Complement

Temperature (°C)	Code	Bit Pattern
85	585	0001001001001001
25 + 0.2906	2	000100000000010
25 + 0.1453	1	000100000000001
25	0	000100000000000
25 - 0.1453	-1	000111111111111
25 - 0.2906	-2	000111111111110
-40	-447	000111001000001

Table 9. Temperature Data Coding, Offset Binary

Temperature (°C)	Code	Bit Pattern
85	2633	0001101001001001
25 + 0.2906	2050	000110000000010
25 + 0.1453	2049	000110000000001
25	2048	000110000000000
25 - 0.1453	2047	000111111111111
25 - 0.2906	2046	000111111111110
-40	1601	0001011001000001

Table 10. ADC Data Coding, Twos Complement

Input Level (V)	Code ¹	Bit Pattern
2	1638	0010011001100110
0.002442	2	001000000000010
0.001221	1	001000000000001
0	0	001000000000000
-0.001221	-1	001011111111111
-0.002442	-2	001011111111110
-2	-1638	0010100110011010

¹ Code for AIN1 used in 3rd and 4th bits (11 for AIN2).

Table 11. ADC Data Coding, Offset Binary

Input Level (V)	Code ¹	Bit Pattern
2	3686	0010011001100110
0.002442	2050	001010000000010
0.001221	2049	001010000000001
0	2048	001010000000000
-0.001221	2047	001011111111111
-0.002442	2046	001011111111110
-2	410	0010000110011010

¹ Code for AIN1 used in 3rd and 4th bits (11 for AIN2).

ADIS16080

OUTLINE DIMENSIONS

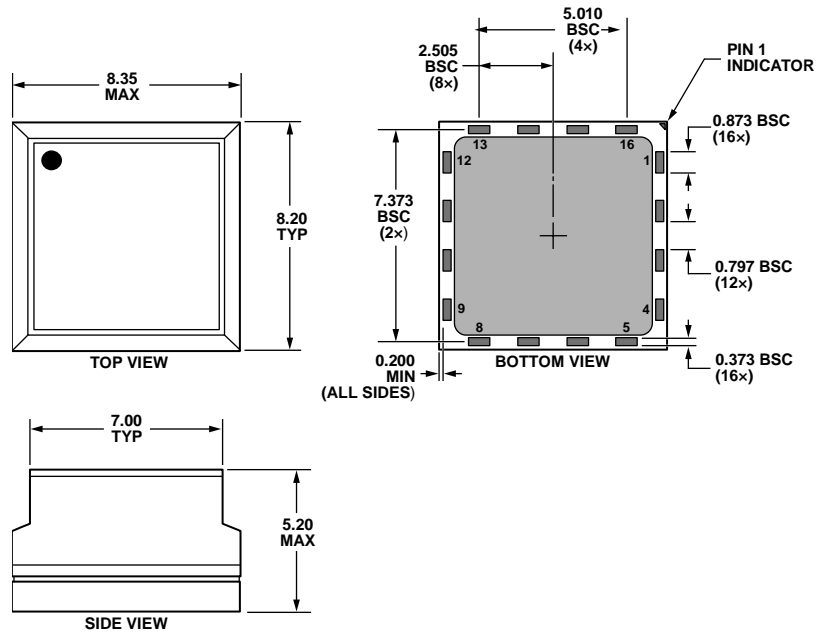

Figure 23. 16-Terminal Stacked Land Grid Array [LGA]
(CC-16-1)

Dimensions shown in millimeters

ORDERING GUIDE

Model	Temperature Range	Package Description	Package Option
ADIS16080ACCZ ¹	-40°C to +85°C	16-Terminal Stacked Land Grid Array (LGA)	CC-16-1
ADIS16080/PCBZ ¹		Evaluation Board	

¹ Z = RoHS Compliant Part.

NOTES

ADIS16080

NOTES